



## **DER**

derivatori a norme DIN  
per strumenti in corrente continua



## **C48**

commutatori amperometrici e voltmetrici  
da pannello frontale 48x48 mm



## **CD3**

commutatori amperometrici e voltmetrici  
3 moduli



## **AV**

morsettiere sigillabili per contatori



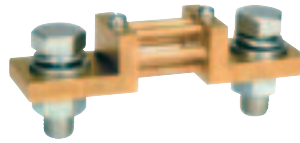

Modello	DER								
	60mV			100mV			150mV		
Caduta di tensione	Codice di ordinazione	Stock		Codice di ordinazione	Stock		Codice di ordinazione	Stock	
Portata									
1A	DER060A100	•		DER100A100			DER150A100		
1,5A	DER060A150	•		DER100A150			DER150A150		
2A	DER060A200	•		DER100A200			DER150A200		
2,5A	DER060A250	•		DER100A250			DER150A250		
3A	DER060A300	•		DER100A300			DER150A300		
4A	DER060A400	•		DER100A400			DER150A400		
5A	DER060A500	•		DER100A500			DER150A500		
6A	DER060A600	•		DER100A600			DER150A600		
8A	DER060A800	•		DER100A800			DER150A800		
10A	DER060B100	•		DER100B100			DER150B100	•	
15A	DER060B150	•		DER100B150			DER150B150	•	
20A	DER060B200	•		DER100B200			DER150B200		
25A	DER060B250	•		DER100B250			DER150B250	•	
30A	DER060B300	•		DER100B300			DER150B300		
40A	DER060B400	•		DER100B400			DER150B400	•	
50A	DER060B500	•		DER100B500			DER150B500		
60A	DER060B600	•		DER100B600			DER150B600	•	
80A	DER060B800	•		DER100B800			DER150B800		
100A	DER060C100	•		DER100C100			DER150C100	•	
120A	DER060C120	•		DER100C120			DER150C120		
150A	DER060C150	•		DER100C150			DER150C150	•	
200A	DER060C200	•		DER100C200			DER150C200		
250A	DER060C250	•		DER100C250			DER150C250	•	
300A	DER060C300	•		DER100C300			DER150C300		
400A	DER060C400	•		DER100C400			DER150C400	•	
500A	DER060C500	•		DER100C500			DER150C500		
600A	DER060C600	•		DER100C600			DER150C600	•	
800A	DER060C800	•		DER100C800			DER150C800		
1000A	DER060D100	•		DER100D100			DER150D100		
1200A	DER060D120	•		DER100D120			DER150D120		
1500A	DER060D150	•		DER100D150			DER150D150		
2000A	DER060D200	•		DER100D200			DER150D200		
2500A	DER060D250	•		DER100D250			DER150D250		
3000A	DER060D300			DER100D300			DER150D300		
4000A	DER060D400			DER100D400			DER150D400		
5000A	DER060D500			DER100D500			DER150D500		
6000A	DER060D600			DER100D600			DER150D600		



# Commutatori amperometrici e voltmetrici



Modello	C48								
Esecuzione	da pannello, mascherina frontale 48x48 mm								
Descrizione	Codice di ordinazione	Stock		Codice di ordinazione	Stock		Codice di ordinazione	Stock	
commutatore amperometrico unipolare per 3 riduttori (12A-690V)	AV104	•							
commutatore voltmetrico 3 tensioni concatenate (12A-690V)				AV105	•				
commutatore voltmetrico 3 tensioni concatenate 3 fase-neutro (12A-690V)							AV106	•	



Modello	CD3								
Esecuzione	da retroquadro, 3 moduli								
Descrizione	Codice di ordinazione	Stock		Codice di ordinazione	Stock		Codice di ordinazione	Stock	
commutatore amperometrico unipolare per 3 riduttori (12A-690V)	AV114	•							
commutatore voltmetrico 3 tensioni concatenate (12A-690V)				AV115	•				
commutatore voltmetrico 3 tensioni concatenate 3 fase-neutro (12A-690V)							AV116	•	

# Morsettiere sigillabili per contatori

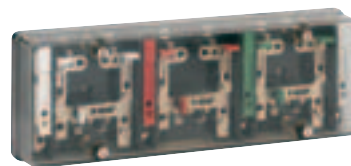
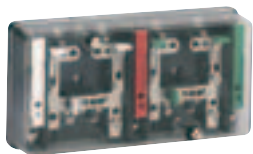

Descrizione	Codice di ordinazione	Stock		Codice di ordinazione	Stock	
morsettiera sigillabile per contatore trifase 2 sistemi	<b>AV201</b>	•				
morsettiera sigillabile per contatore trifase 3 sistemi				<b>AV202</b>	•	

**Commutatori**

AV104 / AV114

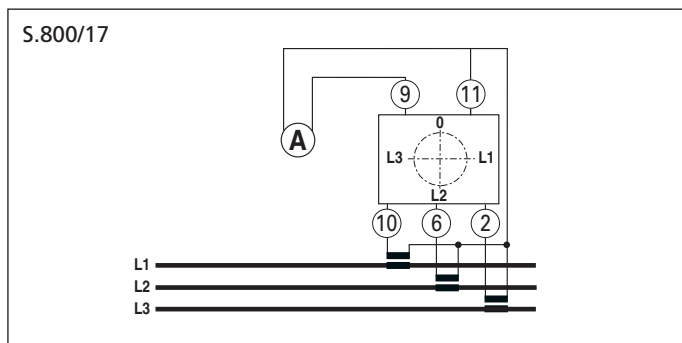

AV105 / AV115

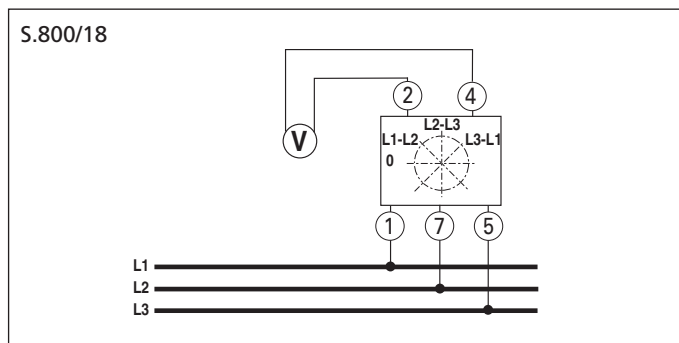

AV106 / AV116

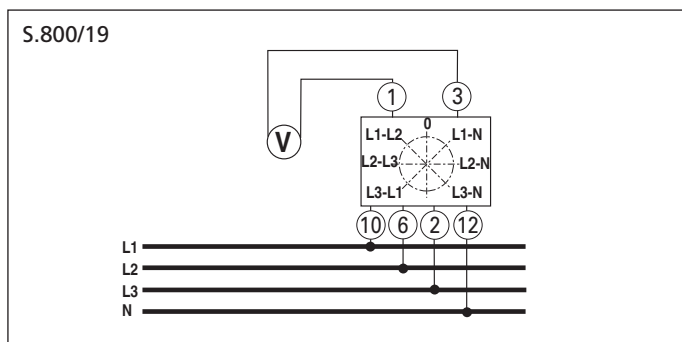

**Morsettiere sigillabili**

AV201

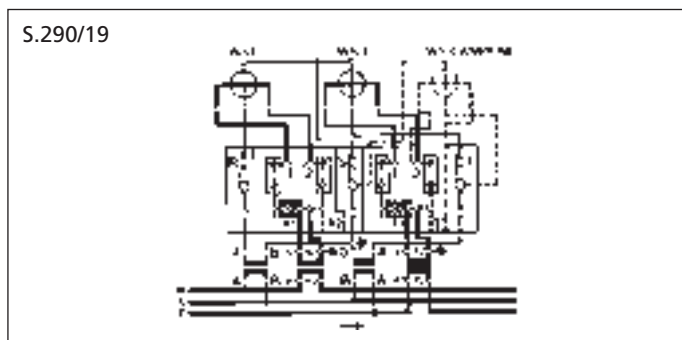

Contatore trifase 2 sistemi

AV202

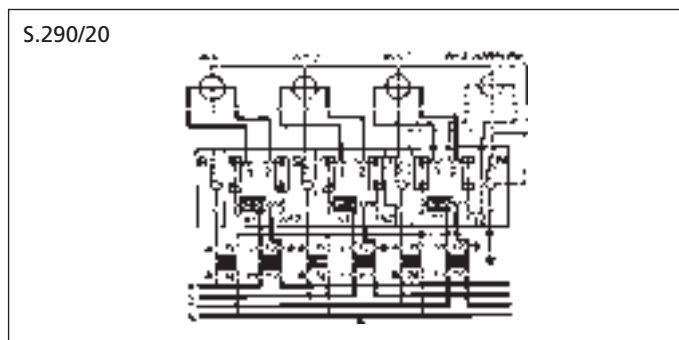

Contatore trifase 3 sistemi

**DER**

Serie DER a norme DIN (escluso 200A / 60mV / 150mV)

Portata A	fig.	A	B	C	D	E	F	G	H	I
<b>Caduta di tensione 60mV</b>										
1-1,5-2-2,5-3-4-5	1	90	28	20	—	—	8	—	78	—
6-8-10-15-20-25	1	90	28	20	—	—	8	—	78	—
30-40-50-60-80-100-120-150-200	1	100	33	20	—	—	8	—	80	—
250-300	2	145	55	30	—	—	10	10	105	30
400-500-600	2	145	55	40	—	—	10	10	105	30
800-1000	2	165	65	60	—	—	10	10	115	30
1200-1500	3	165	65	90	21	48	10	10	115	30
2000-2500	3	165	65	120	30	60	10	10	115	30
3000-4000	4	165	65	120	30	60	15	10	115	60
5000-6000	5	175	70	154	25	52	25	15	125	130
<b>Caduta di tensione 100mV</b>										
1-1,5-2-2,5-3-4-5	1	90	28	20	—	—	8	—	78	—
6-8-10-15-20-25	1	90	28	20	—	—	8	—	78	—
30-40-50-60-80-100-120-150	1	123	33	20	—	—	8	—	103	—
200-250-300	2	168	55	30	—	—	10	10	128	30
400-500-600	2	168	55	40	—	—	10	10	128	30
800-1000	2	188	65	60	—	—	10	10	138	30
1200-1500	3	188	65	90	21	48	10	10	138	30
2000-2500	3	188	65	120	30	60	10	10	138	30
3000-4000	4	188	65	120	30	60	15	10	138	60
5000-6000	5	198	70	154	25	52	25	15	148	130
<b>Caduta di tensione 150mV</b>										
1-1,5-2-2,5-3-4-5	1	90	28	20	—	—	8	—	78	—
6-8-10-15-20-25	1	90	28	20	—	—	8	—	78	—
30-40-50-60-80-100-120-150-200	1	225	33	25	—	—	8	—	205	—
250-300	2	270	55	30	—	—	10	10	230	30
400-500-600	2	270	55	40	—	—	10	10	230	30
800-1000	2	290	65	60	—	—	10	10	240	30
1200-1500	3	290	65	90	21	48	15	10	240	60
2000-2500	3	290	65	120	30	60	15	10	240	60
3000-4000	4	300	70	120	30	60	25	15	250	130
5000-6000	5	300	70	154	25	52	25	15	250	130

Fig. 1

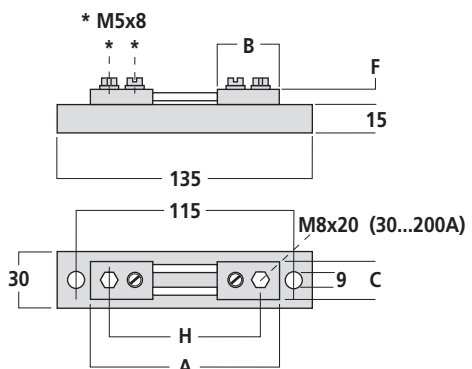

Su basetta isolante fino a 25A

Fig. 2

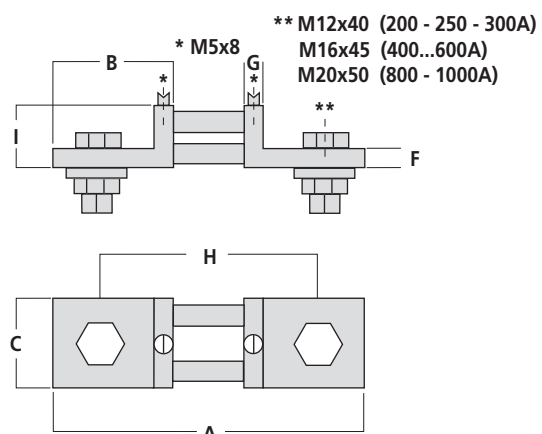

Fig. 3

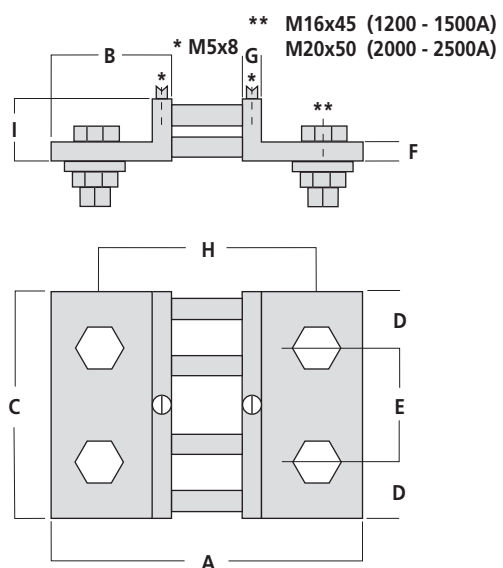

Fig. 4

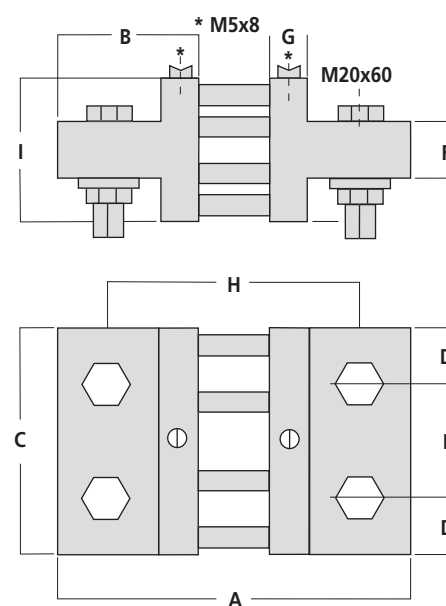
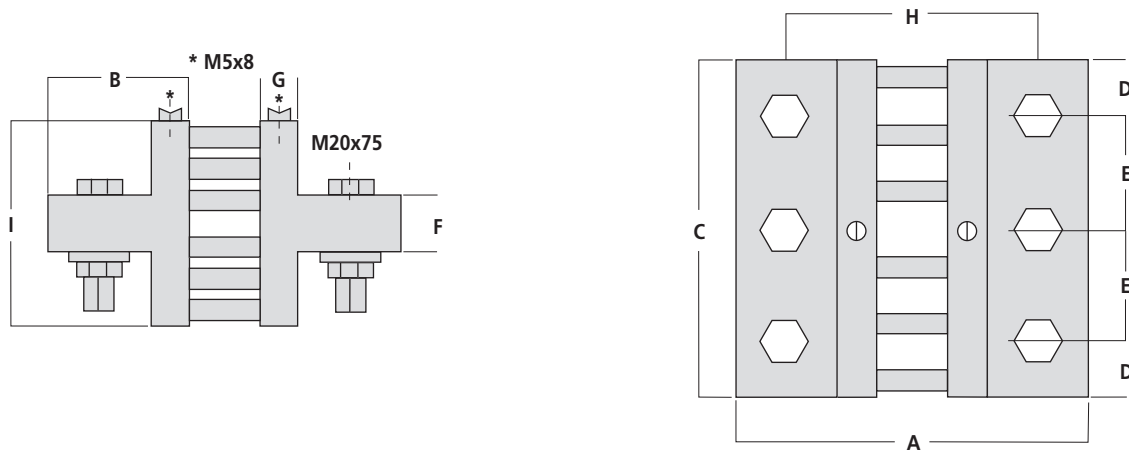
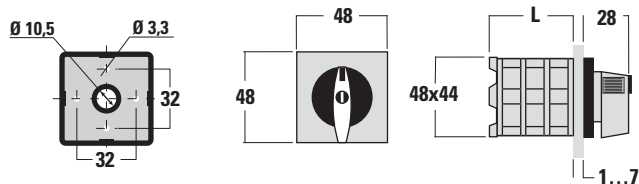

Fig. 5



## AV104 / AV105 / AV106 - commutatori da pannello



AV105 (L = 53) / AV104 - 106 (L = 63)

## AV114 / AV115 / AV116 - commutatori da retroquadro

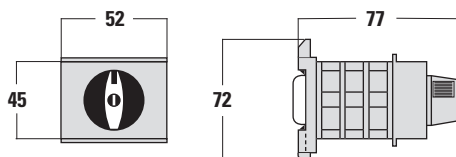

3 Moduli

## AV201 - morsettieria sigillabile

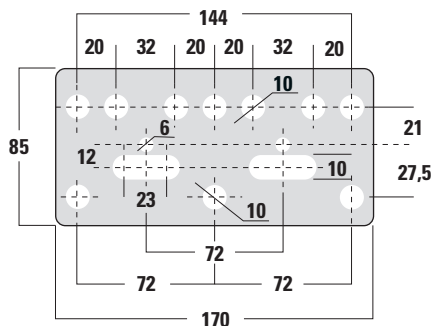

## AV202 - morsettieria sigillabile

